

Waterproof Standard Wiper Motor

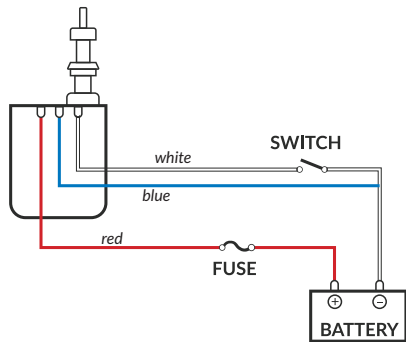

All Sea-Dog wiper motors have the “coast-to-park” features, which means that when power is cut to the motor, the motor will “coast” to its original set position at the bottom or top of the windshield.

The park position is determined by facing the windshield from the outside of the boat and deciding if the motor should stop when it moves to park in the clockwise direction (right hand park) or when it moves to park in the counterclockwise direction (left hand park).

- Powers up to a 14" x 14" arm and blade combination
- Adjustable sweep and park settings (80° or 110° sweep; left or right park)
- Stainless steel base plate, shaft, and knurled drive nut
- Corrosion-proof aluminum case
- Fits the same footprint as almost all competitive standard (STD) motors

Sweep Set Adjustment (80° or 110°)

1. Unscrew Shaft Plate/ Remove Shaft Plate & Motor from Housing

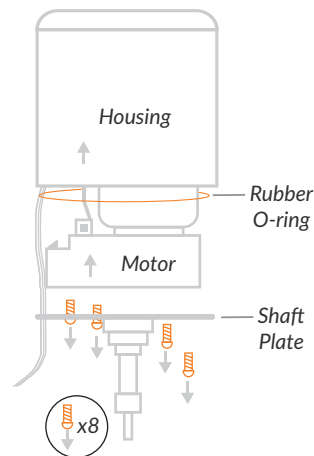

Remove **eight screws** from the shaft plate and carefully remove the shaft plate and inner motor from housing. (note the placement of the small black **o-ring** in the channel of the housing)

2. Adjust Transmission Arm

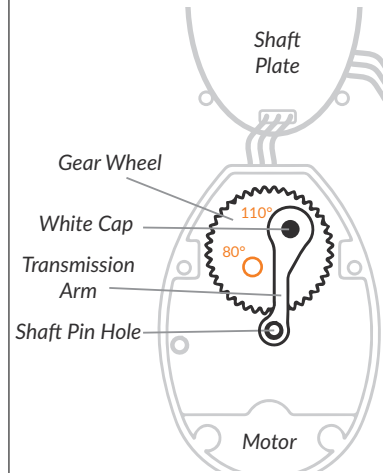

Inside the motor, remove the white cap holding the transmission arm in place then relocate the transmission arm to the desired sweep set: **110°** at 1 o'clock on the gear wheel, **80°** at 8 o'clock on the gear wheel. Replace white cap.

3. Replace Shaft Plate & Motor; Reassemble

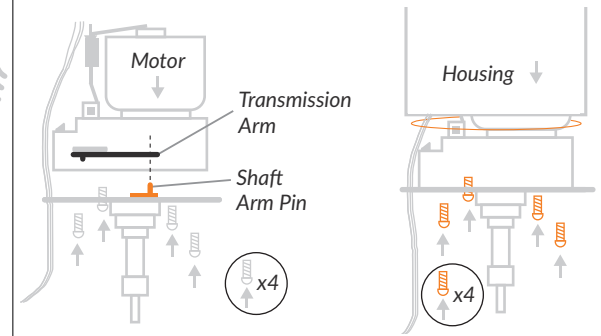

a. Making sure the **shaft arm pin** is placed into the hole at the opposite end of the transmission arm, replace shaft plate to the inner motor and attach with the four inner screws.

b. Making sure the **o-ring** stays in the channel on the housing, drop the inner motor into the motor housing and refasten the shaft plate to the housing using the **four remaining screws**

Note: The o-ring must sit completely in the channel to maintain motor's waterproof properties

Left/Right Self Parking Adjustment

1. Open / Remove Housing

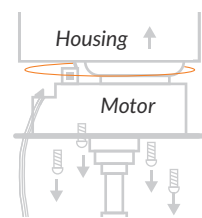

Remove the four outer screws from the shaft plate and remove the outer housing, exposing motor components. (note the placement of the small black **o-ring** in the channel of the housing)

2. Adjust Transmission Plate

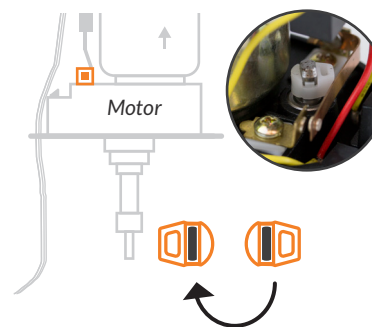

Using a small flat tip screwdriver, remove the **plastic cam**, rotate it 180°, and replace.

3. Replace & Fasten Housing

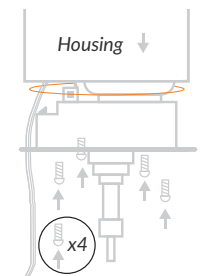

Making sure the **o-ring** stays in the channel on the housing, drop the inner motor into the motor housing and refasten the shaft plate to the housing using the four screws.